

Bestell-Nr.	Brutto
R5007A	5,43 €
R5008	30,55 €
R5010	11,96 €
R5013	27,61 €
R5014	26,78 €
R5002	9,21 €
C45	21,16 €
CR50	3,81 €
Ta50 Stahl pro lfm	7,90 €

alle Preise zzgl. MwSt.

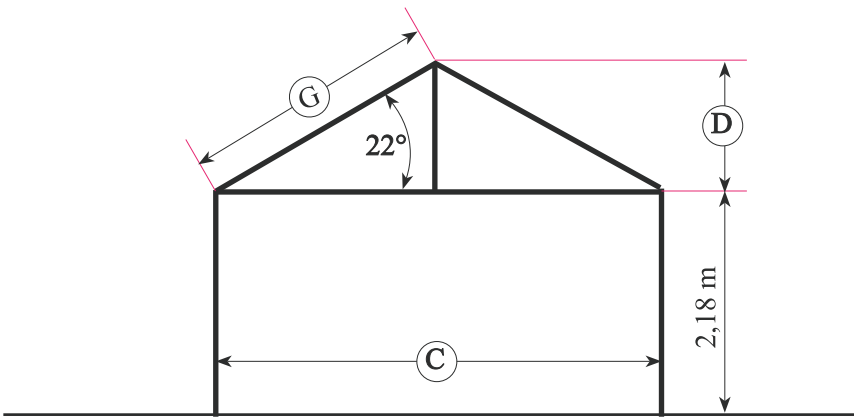

X	A	B	C	D	G
2,00 m	1,835 m	1,300 m	1,767 m	0,340 m	0,992 m
2,50 m	2,335 m	1,640 m	2,267 m	0,468 m	1,272 m
3,00 m	2,835 m	2,015 m	2,767 m	0,560 m	1,535 m
3,50 m	3,335 m	2,393 m	3,267 m	0,725 m	1,834 m
4,00 m	3,835 m	2,769 m	3,767 m	0,855 m	2,115 m

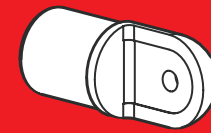

R5007A

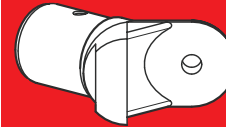

R5010

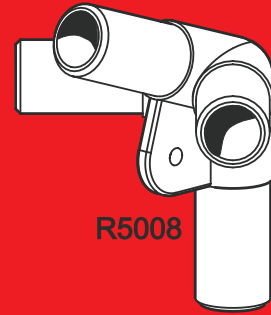

R5008

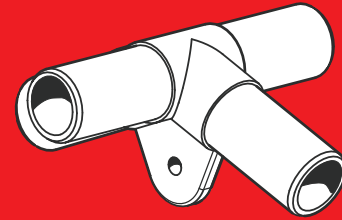

R5013

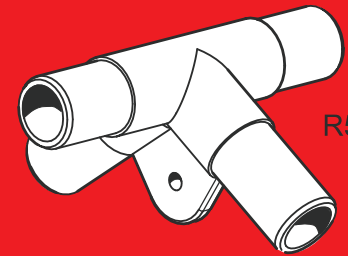

R5014



R5002

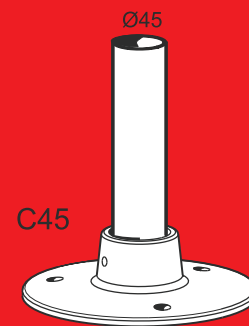

C45



CR50



Ta50 Stahl